

Varenummer: 438000380

Beskrivelse: Rota-fix spændelement SD 380

## Mål

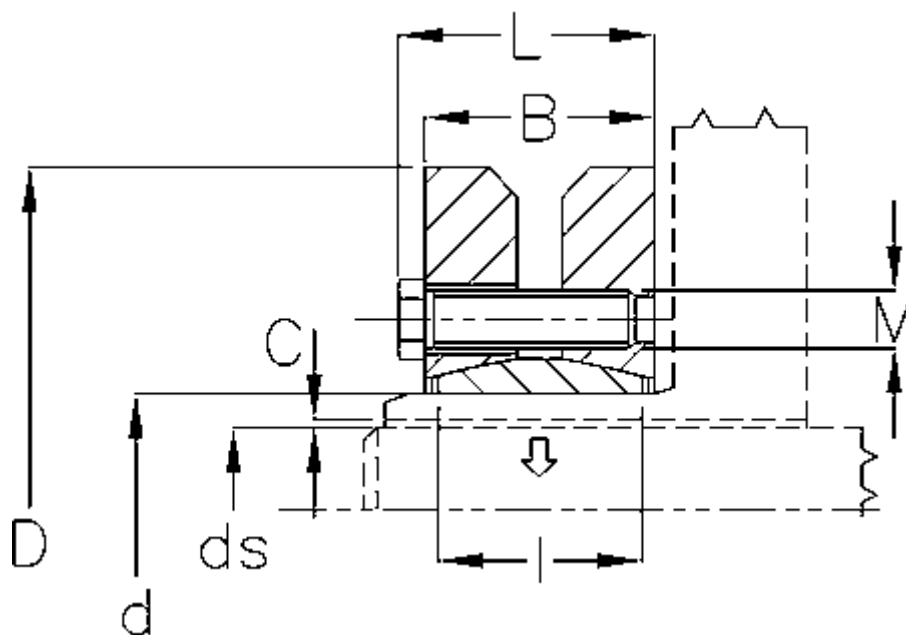

B mm	= 168
C maks.	= 0,111
d H8 mm	= 380
D mm	= 645
ds mm	= 290
F kN aksialkraft	= 3900
L mm	= 183
l mm	= 144

M mm	= M24
T Nm drejningsmoment	= 570000
Ts Nm boltetilspændingsmoment	= 840